

IMPORTANT INSTRUCTIONS

For Installation LS853LED SERIES



Warning: The Luminaire should only be used complete with its protective shield (cover)

Lumascap Lighting Industries Pty Ltd
38-44 Enterprise Street, Cleveland, QLD 4163, Australia
PO Box 1875, Cleveland D.C., QLD 4163, Australia
T 07 3286 2299
F 07 3286 6599
E sales@lumascap.com.au
W www.lumascap.com.au

Warning: When mounting fixtures, parts provided by Lumascap must be used.. Always check maximum wattage and lamp type before relamping. Follow lamp manufacturers instructions for lamp replacement. Failing to follow these instructions will void warranty.

1 CAUTION



NO POWER TOOLS



DO NOT OVERTIGHTEN



NO DOWNWARD FORCE

Do not use power tools to tighten screws. Do not exert downward force on screws while not fully tightened. Do not overtighten screws.

2

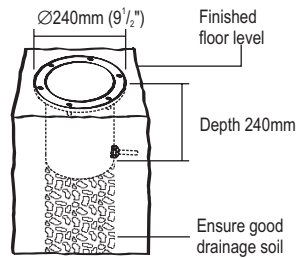

Locate Fixtures

Site fixture, in proximity to cabling, in gravel, soil or concrete. Use discretion in locating fixtures as glass can become very hot and may burn.

3

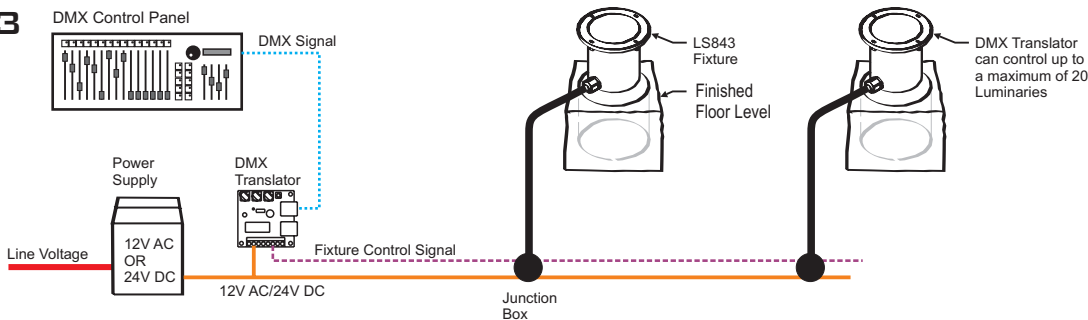

Installation Configuration

Install Transformer and DMX Translator in a suitable locations. Wire cables from luminaries in parallel with supply, (power and control signal). Example shown is typical installation. Separate DMX Translators required for individual control of luminaries.

4

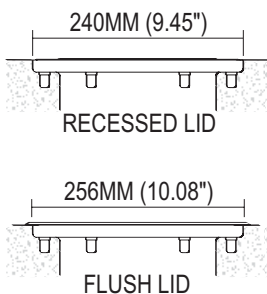

Mount Fixture.

Mount fixture such that the top lip of flange is flush with finished floor level, as shown above.

5

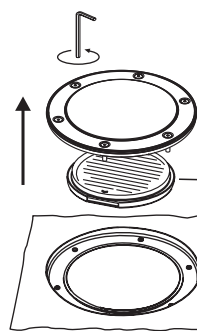

Open Fixture

Loosen screws with allen key provided. If necessary gently lever lid out with large screwdriver. Remove components as shown.

LS688 is an optional component.

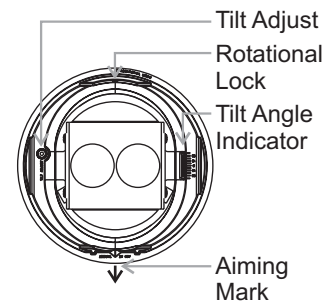

Gimbal Features.

SERVICING/ RE-AIMING PROCEDURE

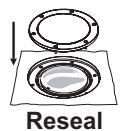
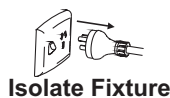

B IMPORTANT INSTRUCTIONS

For Installation LS853LED SERIES



Warning: The Luminaire should only be used complete with its protective shield (cover)

Lumascap Lighting Industries Pty Ltd
38-44 Enterprise Street, Cleveland, QLD 4163, Australia
PO Box 1875, Cleveland D.C., QLD 4163, Australia
T 07 3286 2299
F 07 3286 6599
E sales@lumascap.com.au
W www.lumascap.com.au

Warning: When mounting fixtures, parts provided by Lumascap must be used.. Always check maximum wattage and lamp type before relamping. Follow lamp manufacturers instructions for lamp replacement. Failing to follow these instructions will void warranty.

6

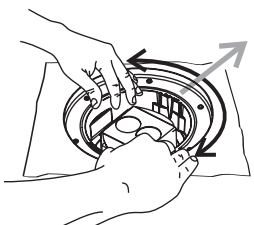

Target Gimbal 1.
Rotate gimbal until the **Aiming Mark** is targeted as desired.

7

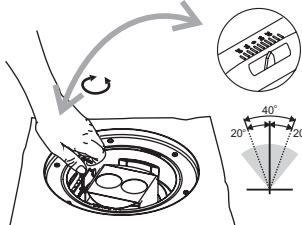

Target Gimbal 2.
Adjust gimbal tilt angle by rotating **Tilt Adjust** screw with Allen key supplied.
Approximate angle can be read from the **Tilt Angle Indicator**.

8

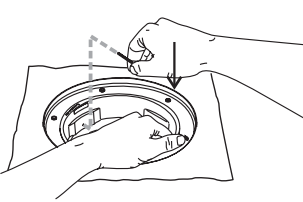

Lock Gimbal.
Whilst exerting downward pressure on gimbal, tighten Rotational Lock grub screw.

9

NOTE: This step is only necessary when dealing with the LS688 Wallwash lens

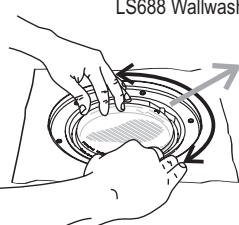

Target Wallwash Lens
With lamp illuminated insert wallwash lens and rotate until targeted as required.

10

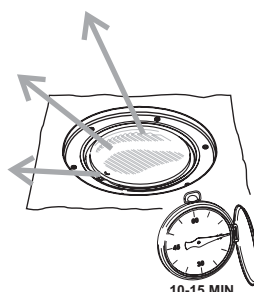

Run Fixture
Replace accessories and allow fixture to burn for 10-15 minutes to allow any moisture in fixture to evaporate.

11

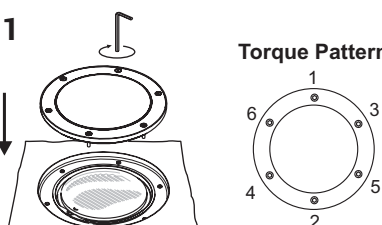

Seal Fixture.
Ensure seal and sealing surface is clean. Clean glass if necessary. Incrementally tighten lid screws using the 3mm Allen key supplied. Lumascap recommends tightening in the above Torque Pattern to 2.5 - 3 N.m.. **DO NOT OVER TIGHTEN.**